

*november 2005*

# **BROMSSLANGAR**

## **HARLEY DAVIDSON**



**STÅLOMSPUNNA**



**GUMMI**

# **BROMSKLOSSAR**

## **HARLEY DAVIDSON**

### **BUELL**



## Russell stålomspunna rostfria bromsslängor och Accel bromsslängor i gummi till Harley Davidson.

Detta uppslag visar de olika typer av bromsslängor som vi har. Vi rekommenderar att du jämför dina nuvarande slängor med dessa bilder innan du beställer, för att vara säker på att få rätt släng.

**OBS!** Rekommendationstabellen på kommande sidor bygger på standard/original bromssystem.



Mellan dessa punkter mäts slängarna.  
Angivna längder bygger på tillverkarnas uppgifter och är ca-mått.

### Typ 1

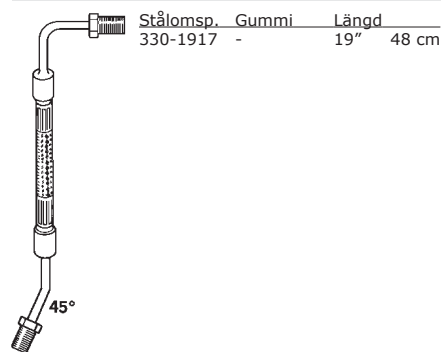

### Typ 2

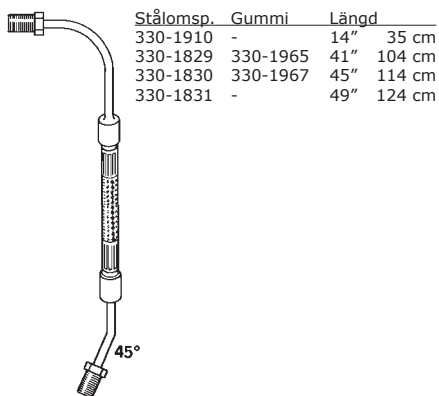

### Typ 3

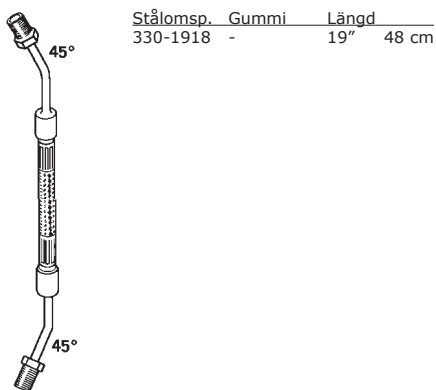

### Typ 3A

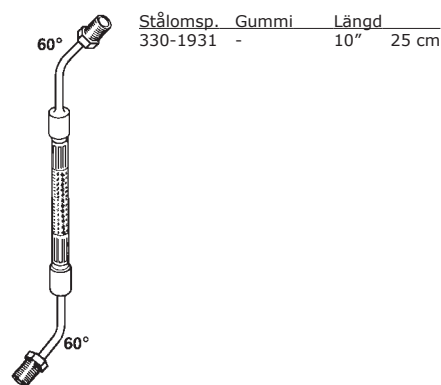

### Typ 4

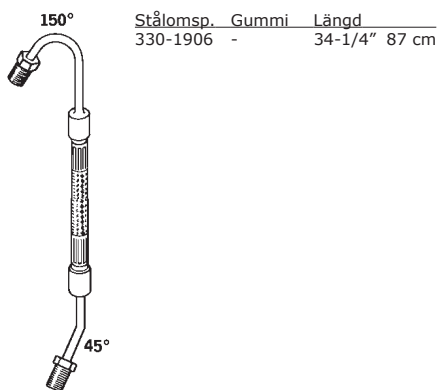

### Typ 5

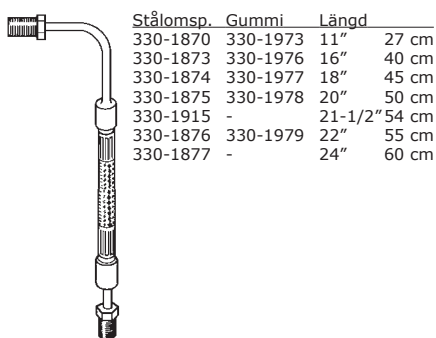

### Typ 6

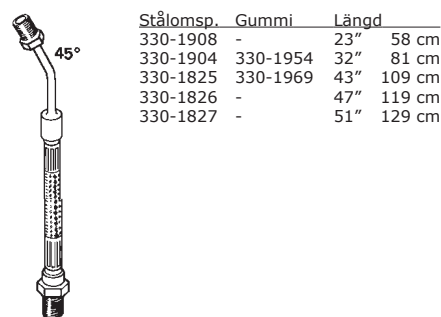

### Typ 7

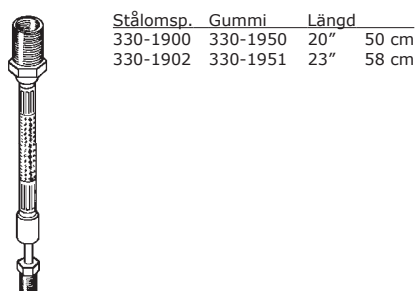

### Typ 7A

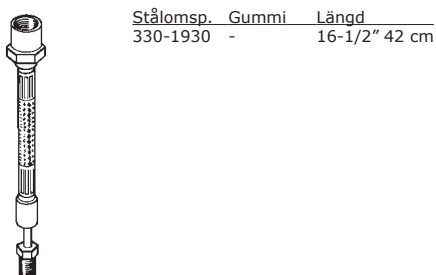

### Typ 8A

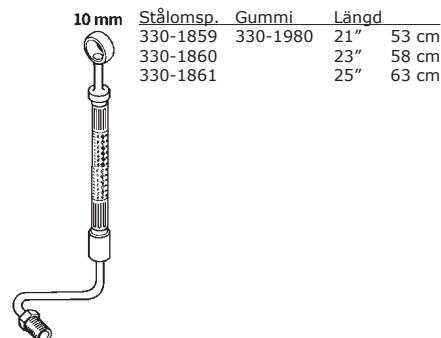

### Typ 9

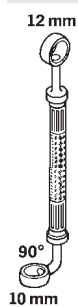
12 mm	Stålomsp.	Gummi	Längd
	330-1888	-	36-1/2" 92 cm
	330-1882	-	37" 93 cm
	330-1883	-	39" 98 cm
	330-1841	-	40" 101 cm
	330-1884	-	41" 104 cm
	330-1987	-	42" 106 cm
	330-1850	-	43" 109 cm
	330-1885	-	43" 109 cm
	330-1887	-	44" 111 cm
	330-1847	330-1991	44" 111 cm
	330-1852	330-1996	45" 114 cm
	330-1856	330-1993	46" 116 cm
	330-1853	330-1997	47" 119 cm
	330-1857	330-1994	48" 121 cm
	330-1854	330-1998	49" 124 cm
	330-1849	330-1995	50" 127 cm
	330-1855	-	51" 129 cm
	330-1858	-	52" 132 cm

### Typ 9A

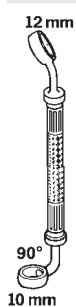
12 mm	Stålomsp.	Gummi	Längd
	330-1868	-	40" 101 cm

### Typ 9B

12 mm	Stålomsp.	Gummi	Längd
	330-1886	330-1999	38" 96 cm

### Typ 10

10 mm	Stålomsp.	Gummi	Längd
	330-1837	-	22" 55 cm
	330-1838	-	24" 60 cm
	330-1839	-	26" 65 cm

### Typ 11

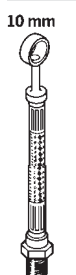
10 mm	Stålomsp.	Gummi	Längd
	330-1833	-	43" 109 cm
	330-1834	-	45" 114 cm
	330-1835	-	47" 119 cm

### Typ 13

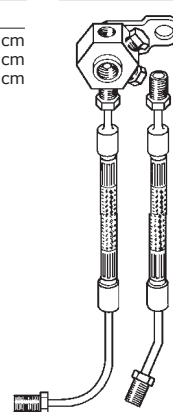
10 mm	Stålomsp.	Gummi	Längd
	330-1932	330-1955	12" 30 cm

### Typ 14

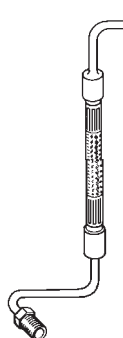
10 mm	Stålomsp.	Gummi	Längd
	330-1890	-	13" 33 cm
	330-1898	-	20" 50 cm
	330-1896	-	22" 55 cm

### Typ 14A

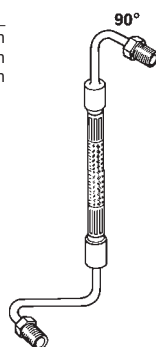
90°	Stålomsp.	Gummi	Längd
	330-1893	-	18" 45 cm

### Typ 15

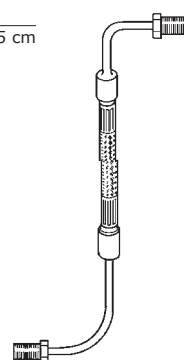
10 mm	Stålomsp.	Gummi	Längd
	330-1914	-	18" 45 cm

Modell	Årsmodell	Typ	Harley OEM	Std/för-längning, tum	Total längd, tum	Std/för-längning, cm	Total längd, cm	Stål-hölje	Gummi-hölje
<b>XL 1973-1977 FRAM (åtgång 1)</b>									
XLH, XLCH	1973	6	45521-73	STD = 47"	47"	STD = 119 cm	119 cm	<b>330-1826</b>	-
XLH, XLCH	1974-1976		45521-74A	STD = 41"	41"	STD = 104 cm	104 cm	<b>330-1829</b>	<b>330-1965</b>
XLH, XLCH	1974-1976		45521-74A	+4"	45"	+10 cm	114 cm	<b>330-1830</b>	<b>330-1967</b>
XLH, XLCH	1974-1976		45521-74A	+8"	49"	+20 cm	124 cm	<b>330-1831</b>	-
XLH, XLCH, XLT	1977		45519-77	STD = 41"	41"	STD = 104 cm	104 cm	<b>330-1829</b>	<b>330-1965</b>
XLH, XLCH, XLT	1977		45519-77	+4"	45"	+10 cm	114 cm	<b>330-1830</b>	<b>330-1967</b>
XLH, XLCH, XLT	1977		45519-77	+8"	49"	+20 cm	124 cm	<b>330-1831</b>	-
<b>XL 1977-1981 FRAM/ÖVRE (åtgång 1)</b>									
XL, XLCH	1978-1979	5	45121-77	STD = 16"	16"	STD = 40 cm	40 cm	<b>330-1873</b>	<b>330-1976</b>
XL, XLCH	1978-1979	5	45121-77	+2"	18"	+5 cm	45 cm	<b>330-1874</b>	<b>330-1977</b>

Fortsättning nästa uppslag.

Modell	Årsmodell	Typ	Harley OEM	Std/för- längning, tum	Total längd, tum	Std/för- längning, cm	Total längd, cm	Stål- hölje	Gummi- hölje
<b>Fortsättning. XL 1977-1981 FRAM/ÖVRE (åtgång 1)</b>									
XL, XLCH	1978-1979	5	45121-77	+4"	20"	+10 cm	50 cm	<b>330-1875</b>	<b>330-1978</b>
XL, XLCH	1978-1979	5	45121-77	+6"	22"	+15 cm	55 cm	<b>330-1876</b>	<b>330-1979</b>
XL, XLCH	1978-1979	5	45121-77	+8"	24"	+20 cm	60 cm	<b>330-1877</b>	-
XLS	1979	5	45114-77	STD = 11"	11"	STD = 27 cm	27 cm	<b>330-1870</b>	<b>330-1973</b>
XLH	1980	14A	45123-79	STD = 18"	18"	STD = 45 cm	45 cm	<b>330-1893</b>	-
XLS	1980	14	45114-79	STD = 13"	13"	STD = 33 cm	33 cm	<b>330-1890</b>	-
XLH, XLS	1981	14	45125-81	STD = 22"	22"	STD = 55 cm	55 cm	<b>330-1896</b>	-
<b>XL 1977-1981 FRAM/NEDRE (åtgång 2)</b>									
XLCR	1977-1978	5	45121-77	STD = 16"	16"	STD = 40 cm	40 cm	<b>330-1873</b>	<b>330-1976</b>
XL, XLCH	1978-1981	5	45121-77	STD = 16"	16"	STD = 40 cm	40 cm	<b>330-1873</b>	<b>330-1976</b>
XL, XLCH	1978-1981	5	45121-77	+2"	18"	+5 cm	45 cm	<b>330-1874</b>	<b>330-1977</b>
XL, XLCH	1978-1981	5	45121-77	+4"	20"	+10 cm	50 cm	<b>330-1875</b>	<b>330-1978</b>
XL, XLCH	1978-1981	5	45121-77	+6"	22"	+15 cm	55 cm	<b>330-1876</b>	<b>330-1979</b>
XL, XLCH	1978-1981	5	45121-77	+8"	24"	+20 cm	60 cm	<b>330-1877</b>	-
XLS	1979-1981	5	45123-77	STD = 18"	18"	+5 cm	45 cm	<b>330-1874</b>	<b>330-1977</b>
XLS	1979-1981	5	45123-77	+2"	20"	+10 cm	50 cm	<b>330-1875</b>	<b>330-1978</b>
XLS	1979-1981	5	45123-77	+4"	22"	+15 cm	55 cm	<b>330-1876</b>	<b>330-1979</b>
XLS	1979-1981	5	45123-77	+6"	24"	+20 cm	60 cm	<b>330-1877</b>	-
<b>XL 1982 FRAM/ÖVRE (åtgång 1)</b>									
XLH, XLS	1982	8A	45126-82	STD = 21"	21"	STD = 53 cm	53 cm	<b>330-1859</b>	<b>330-1980</b>
XLH, XLS	1982	8A	45126-82	+2"	23"	+5 cm	58 cm	<b>330-1860</b>	-
XLH, XLS	1982	8A	45126-82	+4"	25"	+10 cm	63 cm	<b>330-1861</b>	-
<b>XL 1982 FRAM/NEDRE (åtgång 2)</b>									
XLH	1982	5	45121-77	STD = 16"	16"	STD = 40 cm	40 cm	<b>330-1873</b>	<b>330-1976</b>
XLH	1982	5	45121-77	+2"	18"	+5 cm	45 cm	<b>330-1874</b>	<b>330-1977</b>
XLH	1982	5	45121-77	+4"	20"	+10 cm	50 cm	<b>330-1875</b>	<b>330-1978</b>
XLH	1982	5	45121-77	+6"	22"	+15 cm	55 cm	<b>330-1876</b>	<b>330-1979</b>
XLH	1982	5	45121-77	+8"	24"	+20 cm	60 cm	<b>330-1877</b>	-
XLS	1982	5	45123-77	STD = 18"	18"	STD = 45 cm	45 cm	<b>330-1874</b>	<b>330-1977</b>
XLS	1982	5	45123-77	+2"	20"	+5 cm	50 cm	<b>330-1875</b>	<b>330-1978</b>
XLS	1982	5	45123-77	+4"	22"	+10 cm	55 cm	<b>330-1876</b>	<b>330-1979</b>
XLS	1982	5	45123-77	+6"	24"	+15 cm	60 cm	<b>330-1877</b>	-
<b>XL 1983 FRAM/ÖVRE (åtgång 1. OBS! 330-1985 innehåller 3 delar, 1 st övre + 2 st nedre)</b>									
XLH	1983		45121-83	STD = 22"	22"	STD = 55 cm	55 cm	<b>330-1864</b>	-
XLH	1983		45121-83	+2"	24"	+5 cm	60 cm	<b>330-1865</b>	-
XLH	1983		45121-83	+4"	26"	+10 cm	65 cm	<b>330-1866</b>	-
XLS	1983		45130-83	STD = 30"	30"	STD = 76 cm	76 cm	<b>330-1878</b>	<b>330-1985</b>
XLS	1983		45130-83	+2"	32"	+5 cm	81 cm	<b>330-1879</b>	-
XLS	1983		45130-83	+4"	34"	+10 cm	86 cm	<b>330-1880</b>	-
<b>XR 1983-1985 FRAM/ÖVRE+NEDRE (åtgång 1, innehåller 3 delar, 1 st övre + 2 st nedre)</b>									
XR1000	1983-1985		45132-83	STD		STD		<b>330-1869</b>	-
<b>XL 1984-1995 FRAM (åtgång 1)</b>									
XLH	1984-1985	9	45121-84	STD = 42"	42"	STD = 106 cm	106 cm	-	<b>330-1987</b>
XLH	1984-1985	9	45121-84	+2"	44"	+5 cm	111 cm	<b>330-1847</b>	<b>330-1991</b>
XLH	1984-1985	9	45121-84	+4"	46"	+10 cm	116 cm	<b>330-1856</b>	<b>330-1993</b>
XLH	1984-1985	9	45121-84	+6"	48"	+15 cm	121 cm	<b>330-1857</b>	<b>330-1994</b>
XLS	1984-1985	9	45130-84	STD = 37"	37"	STD = 93 cm	93 cm	<b>330-1882</b>	-
XLS	1984-1985	9	45130-84	+2"	39"	+5 cm	98 cm	<b>330-1883</b>	-
XLS	1984-1985	9	45130-84	+4"	41"	+10 cm	104 cm	<b>330-1884</b>	-
XLS	1984-1985	9	45130-84	+6"	43"	+15 cm	109 cm	<b>330-1885</b>	-
XLX	1984-1985	9B	45122-84	STD = 38"	38"	STD = 96 cm	96 cm	<b>330-1886</b>	<b>330-1999</b>

Modell	Årsmodell	Typ	Harley OEM	Std/för-längning, tum	Total längd, tum	Std/för-längning, cm	Total längd, cm	Stål-hölje	Gummi-hölje
<b>Fortsättning. XL 1984-1995 FRAM (åtgång 1)</b>									
XLH 883	1986-2001	9	45143-86	STD = 36-1/2"	36-1/2"	STD = 92 cm	92 cm	330-1888	-
Hugger	1987-1995	9	45121-84	STD = 42"	42"	STD = 106 cm	106 cm	-	330-1987
Hugger	1987-1995	9	45121-84	+2"	44"	+5 cm	111 cm	330-1847	330-1991
Hugger	1987-1995	9	45121-84	+4"	46"	+10 cm	116 cm	330-1856	330-1993
Hugger	1987-1995	9	45121-84	+6"	48"	+15 cm	121 cm	330-1857	330-1994
Hugger	1996-2001	9	45121-96	STD = 36-1/2"	36-1/2"	STD = 92 cm	92 cm	330-1888	-
XLH1100	1986-1987	9	45121-84	STD = 42"	42"	STD = 106 cm	106 cm	330-1844	330-1987
XLH1100	1986-1987	9	45121-84	+2"	44"	+5 cm	111 cm	330-1847	330-1991
XLH1100	1986-1987	9	45121-84	+4"	46"	+10 cm	116 cm	330-1856	330-1993
XLH1100	1986-1987	9	45121-84	+6"	48"	+15 cm	121 cm	330-1857	330-1994
XLH1200	1988-1995	9	45121-88	STD = 44"	44"	STD = 111 cm	111 cm	330-1887	-
<b>XL 1977-1997 BAK (OBS! 330-1922, 330-1932 och 330-1955 säljes parvis)</b>									
XLH, XLCH, XLS	1979	7A	42329-79	16 1/2"	16 1/2"	42 cm	42 cm	330-1930	-
XLH, XLS	1980-1981	3A	44438-80	10"	10"	25 cm	25 cm	330-1931	-
XLH, XLX, XLS, XR1000	1982-1985	13	42484-81/ 44438-82	12"	12"	30 cm	30 cm	330-1932	330-1955
XLH883, Hugger, XLH1100	1987-1997		44438-87	12"/15"	12"/15"	30 cm/38 cm	30 cm/38 cm	330-1922	-
Alla XL-modeller	1987-1997		44438-87	12"/15"	12"/15"	30 cm/38 cm	30 cm/38 cm	330-1922	-
<b>FL 1958-1999 BAK</b>									
FL, FLH	1958-1962	7	42300-58	20"	20"	50 cm	50 cm	330-1900	330-1950
FL, FLH	1963-1972	7	42300-63	23"	23"	58 cm	58 cm	330-1902	330-1951
FL, FLH	1973-1980	6	42300-73A	32"	32"	81 cm	81 cm	330-1904	330-1954
FLHS	1980-1982	6	42300-73A	32"	32"	81 cm	81 cm	330-1904	330-1954
FLH, FLHX	1981-1984	4	40912-81	34-1/4"	34-1/4"	87 cm	87 cm	330-1906	-
FLHS	1983-1984	2	41033-82	14"	14"	35 cm	35 cm	330-1910	-
FLST	1986-1987	1	45156-84	19"	19"	48 cm	48 cm	330-1917	-
FLST, FLSTC, FLSTF, FLSTN, FLSTS	1987-1999		40957-87	19"	19"	48 cm	48 cm	330-1919	-
<b>FX 1971-1988 BAK (OBS! 330-1923 säljes parvis)</b>									
FX	1971-1972	7	42300-63	23"	23"	58 cm	58 cm	330-1902	330-1951
FX, FXE, FXEF, FXS, FXB	1978-1982		45151-78	23"	23"	58 cm	58 cm	330-1908	-
FXWG	1980-1982	6	42300-73A	32"	32"	81 cm	81 cm	330-1904	330-1954
FXE	1983	6	45151-78	23"	23"	58 cm	58 cm	330-1908	-
FXEF, FXSB, FXWG, FXDG	1983-1986	2	41033-82	14"	14"	35 cm	35 cm	330-1910	-
FXST, FXSTC	1984-1987	1	45156-84	19"	19"	48 cm	48 cm	330-1917	-
FXST, FXSTC, FXSTS	1987-1988		45156-87	14"	14"	35 cm	35 cm	330-1923	-
<b>FXR ALLA MODELLER 1982-1994 BAK</b>									
Alla modeller	1982-1987	3	40956-82	19"	19"	48 cm	48 cm	330-1918	-
Alla modeller	1987-1994		40956-87	21-1/2"	21-1/2"	54 cm	54 cm	330-1921	-
<b>FLT/FLHT/FLHS/FLHR Road King 1980-1991 BAK</b>									
FLT	1980-1982	15	40971-79	18"	18"	45 cm	45 cm	330-1914	-
Alla modeller	1983	5	40971-83	21-1/2"	21-1/2"	54 cm	54 cm	330-1915	-
Alla modeller	1986-1991		40971-86	23-1/2"	23-1/2"	59 cm	59 cm	330-1920	-
<b>FL 1972-1995 FRAM (åtgång 1 resp. 2)</b>									
FL, FLH, FLHS (åtgång 1)	1972-1981	6	45120-72A	STD = 43"	43"	STD = 109 cm	109 cm	330-1825	330-1969
FL, FLH, FLHS (åtgång 1)	1972-1981	6	45120-72A	+4"	47"	+10 cm	119 cm	330-1826	-
FL, FLH, FLHS (åtgång 1)	1972-1981	6	45120-72A	+8"	51"	+20 cm	129 cm	330-1827	-
FL, FLHS, FLHX (åtgång 2)	1982-1984	11	42304-82	STD = 43"	43"	STD = 109 cm	109 cm	330-1833	-
FL, FLHS, FLHX (åtgång 2)	1982-1984	11	42304-82	+2"	45"	+5 cm	114 cm	330-1834	-
FL, FLHS, FLHX (åtgång 2)	1982-1984	11	42304-82	+4"	47"	+10 cm	119 cm	330-1835	-
FLST (åtgång 1)	1986-1995	9	42305-86	STD = 40"	40"	STD = 101 cm	101 cm	330-1841	-

Fortsättning nästa uppslag.

Modell	Årsmodell	Typ	Harley OEM	Std/för-längning, tum	Total längd, tum	Std/för-längning, cm	Total längd, cm	Stål-hölje	Gummi-hölje
<b>FL 1987-1990 FRAM/ÖVRE+NEDRE (åtgång 1, innehåller 3 delar, 1 st övre + 2 st nedre)</b>									
FLHS	1987-1993		43349-84	STD =		STD =		330-1871	-
<b>FX 1973-1977 FRAM (åtgång 1)</b>									
FX, FXE	1973	6	45521-73	STD = 47"	47"	STD = 119 cm	119 cm	330-1826	-
FX, FXE	1974-1976	2	45521-74A	STD = 41"	41"	STD = 104 cm	104 cm	330-1829	330-1965
FX, FXE	1974-1976	2	45521-74A	+4"	45"	+10 cm	114 cm	330-1830	330-1967
FX, FXE	1974-1976	2	45521-74A	+8"	49"	+20 cm	124 cm	330-1831	-
FX, FXE	1977	2	45519-77	STD = 41"	41"	STD = 104 cm	104 cm	330-1829	330-1965
FX, FXE	1977	2	45519-77	+4"	45"	+10 cm	114 cm	330-1830	330-1967
FX, FXE	1977	2	45519-77	+8"	49"	+20 cm	124 cm	330-1831	-
<b>FX 1977-1981 FRAM/ÖVRE (åtgång 1)</b>									
FXS	1977-1978	5	45114-77	STD = 11"	11"	STD = 27 cm	27 cm	330-1870	330-1973
FX, FXE, FXEF	1978-1979	5	45121-77	STD = 16"	16"	STD = 40 cm	40 cm	330-1873	330-1976
FX, FXE, FXEF	1978-1979	5	45121-77	+2"	18"	+5 cm	45 cm	330-1874	-
FX, FXE, FXEF	1978-1979	5	45121-77	+4"	20"	+10 cm	50 cm	330-1875	330-1978
FX, FXE, FXEF	1978-1979	5	45121-77	+6"	22"	+15 cm	55 cm	330-1876	330-1979
FX, FXE, FXEF	1978-1979	5	45121-77	+8"	24"	+20 cm	60 cm	330-1877	-
FXS	1979	14	45114-79	STD = 13"	13"	STD = 33 cm	33 cm	330-1890	-
FXE, FXEF, FXS	1980	14A	45123-79	STD = 18"	18"	STD = 45 cm	45 cm	330-1893	-
FXWG	1980	14	45008-80	STD = 20"	20"	STD = 50 cm	50 cm	330-1898	-
FXB	1980-81	14	45114-79	STD = 13"	13"	STD = 33 cm	33 cm	330-1890	-
FXE, FXEF, FXS, FXWG	1981	14	45125-81	STD = 22"	22"	STD = 55 cm	55 cm	330-1896	-
<b>FX 1977-1981 FRAM/NEDRE (åtgång 1)</b>									
FX, FXE, FXEF	1978-1981	5	45121-77	STD = 16"	16"	STD = 40 cm	40 cm	330-1873	330-1976
FX, FXE, FXEF	1978-1981	5	45121-77	+2"	18"	+5 cm	45 cm	330-1874	-
FX, FXE, FXEF	1978-1981	5	45121-77	+4"	20"	+10 cm	50 cm	330-1875	330-1978
FX, FXE, FXEF	1978-1981	5	45121-77	+6"	22"	+15 cm	55 cm	330-1876	330-1979
FX, FXE, FXEF	1978-1981	5	45121-77	+8"	24"	+20 cm	60 cm	330-1877	-
FXS, FXB, FXWG	1977-1981	5	45123-77	STD = 18"	18"	STD = 45 cm	45 cm	330-1874	-
FXS, FXB, FXWG	1977-1981	5	45123-77	+2"	20"	+5 cm	50 cm	330-1875	330-1978
FXS, FXB, FXWG	1977-1981	5	45123-77	+4"	22"	+10 cm	55 cm	330-1876	330-1979
FXS, FXB, FXWG	1977-1981	5	45123-77	+6"	24"	+15 cm	60 cm	330-1877	-
<b>FX 1982 FRAM/ÖVRE (åtgång 1)</b>									
FXE, FXS, FXB	1982	8A	45123-82	STD = 21"	21"	STD = 53 cm	53 cm	330-1859	330-1980
FXE, FXS, FXB	1982	8A	45123-82	+2"	23"	58 cm	58 cm	330-1860	-
FXE, FXS, FXB	1982	8A	45123-82	+4"	25"	63 cm	63 cm	330-1861	-
<b>FX 1982 FRAM/NEDRE (åtgång 2)</b>									
FXE	1982	5	45121-77	STD = 16"	16"	STD = 40 cm	40 cm	330-1873	330-1976
FXE	1982	5	45121-77	+2"	18"	+5 cm	45 cm	330-1874	-
FXE	1982	5	45121-77	+4"	20"	+10 cm	50 cm	330-1875	330-1978
FXE	1982	5	45121-77	+6"	22"	+15 cm	55 cm	330-1876	330-1979
FXE	1982	5	45121-77	+8"	24"	+20 cm	60 cm	330-1877	-
FXS, FXB, FXWG	1982	5	45123-77	STD = 18"	18"	STD = 45 cm	45 cm	330-1874	-
FXS, FXB, FXWG	1982	5	45123-77	+2"	20"	+5 cm	50 cm	330-1875	330-1978
FXS, FXB, FXWG	1982	5	45123-77	+4"	22"	+10 cm	55 cm	330-1876	330-1979
<b>Fortsättning. FX 1982 FRAM/NEDRE (åtgång 2)</b>									
FXS, FXB, FXWG	1982	5	45123-77	+6"	24"	+15 cm	60 cm	330-1877	-
<b>FX 1983 FRAM/ÖVRE+NEDRE (åtgång 1, innehåller 3 delar, 1 st övre + 2 st nedre)</b>									
FXWG, FXDG	1983		45113-83	STD		STD		330-1891	-
<b>FX 1984-1998 FRAM (åtgång 1)</b>									
FXE, FXEF	1984-1985	9	45121-84	STD = 42"	42"	STD = 106 cm	106 cm	-	330-1987
FXE, FXEF	1984-1985	9	45121-84	+2"	44"	+5 cm	111 cm	330-1847	330-1991

Modell	Årsmodell	Typ	Harley OEM	Std/för-längning, tum	Total längd, tum	Std/för-längning, cm	Total längd, cm	Stål-hölje	Gummi-hölje
<b>Fortsättning. FX 1984-1998 FRAM (åtgår 1)</b>									
FXE, FXEF	1984-1985	9	45121-84	+4"	46"	+10 cm	116 cm	<b>330-1856</b>	<b>330-1993</b>
FXE, FXEF	1984-1985	9	45121-84	+6"	48"	+15 cm	121 cm	<b>330-1857</b>	<b>330-1994</b>
FXSB	1984-1985	9	45124-84	STD = 44"	44"	STD = 111 cm	111 cm	<b>330-1847</b>	<b>330-1991</b>
FXSB	1984-1985	9	45124-84	+2"	46"	+5 cm	116 cm	<b>330-1856</b>	<b>330-1993</b>
FXSB	1984-1985	9	45124-84	+4"	48"	+10 cm	121 cm	<b>330-1857</b>	<b>330-1994</b>
FXWG	1984-1986	9	45113-84	STD = 45"	45"	STD = 114 cm	114 cm	<b>330-1852</b>	<b>330-1996</b>
FXWG	1984-1986	9	45113-84	+2"	47"	+5 cm	119 cm	<b>330-1853</b>	<b>330-1997</b>
FXWG	1984-1986	9	45113-84	+4"	49"	+10 cm	124 cm	<b>330-1854</b>	<b>330-1998</b>
FXWG	1984-1986	9	45113-84	+6"	51"	+15 cm	129 cm	<b>330-1855</b>	-
FXST, FXSTC	1984-1998	9	45112-84	STD = 46"	46"	STD = 116 cm	116 cm	<b>330-1856</b>	<b>330-1993</b>
FXST, FXSTC	1984-1998	9	45112-84	+2"	48"	+5 cm	121 cm	<b>330-1857</b>	<b>330-1994</b>
FXST, FXSTC	1984-1998	9	45112-84	+4"	50"	+10 cm	127 cm	<b>330-1849</b>	<b>330-1995</b>
FXST, FXSTC	1984-1998	9	45112-84	+6"	52"	+15 cm	132 cm	<b>330-1858</b>	-
<b>FXR 1982-1983 FRAM/ÖVRE (åtgår 1)</b>									
FXR, FXRS	1982-1983	8A	45126-82	STD = 21"	21"	STD = 53 cm	53 cm	<b>330-1859</b>	<b>330-1980</b>
FXR, FXRS	1982-1983	8A	45126-82	+2"	23"	+5 cm	58 cm	<b>330-1860</b>	-
FXR, FXRS	1982-1983	8A	45126-82	+4"	25"	+10 cm	63 cm	<b>330-1861</b>	-
<b>FXR 1982-1983 FRAM/NEDRE (åtgår 2)</b>									
FXR, FXRS	1982-1983	5	45123-77	STD = 18"	18"	STD = 45 cm	45 cm	<b>330-1874</b>	-
FXR, FXRS	1982-1983	5	45123-77	+2"	20"	+5 cm	50 cm	<b>330-1875</b>	<b>330-1978</b>
FXR, FXRS	1982-1983	5	45123-77	+4"	22"	+10 cm	55 cm	<b>330-1876</b>	<b>330-1979</b>
FXR, FXRS	1982-1983	5	45123-77	+6"	24"	+15 cm	60 cm	<b>330-1877</b>	-
<b>FXR 1983 FRAM/ÖVRE+NEDRE (åtgår 1, innehåller 3 delar, 1 st övre + 2 st nedre)</b>									
FXR, FXRS	1983		45124-83	STD		STD		<b>330-1872</b>	-
FXRT	1983		45128-83	STD		STD		<b>330-1867</b>	-
<b>FXR 1984-1994 FRAM (åtgår 1)</b>									
FXR, FXRS, FXRDG, FXRC	1984-1987	9	45121-84	STD = 42"	42"	STD = 106 cm	106 cm	-	<b>330-1987</b>
FXR, FXRS, FXRDG, FXRC	1984-1987	9	45121-84	+2"	44"	+5 cm	111 cm	<b>330-1847</b>	<b>330-1991</b>
FXR, FXRS, FXRDG, FXRC	1984-1987	9	45121-84	+4"	46"	+10 cm	116 cm	<b>330-1856</b>	<b>330-1993</b>
FXR, FXRS, FXRDG, FXRC	1984-1987	9	45121-84	+6"	48"	+15 cm	121 cm	<b>330-1857</b>	<b>330-1994</b>
FXRT	1984	9	45128-84	STD = 43"	43"	STD = 109 cm	109 cm	<b>330-1850</b>	-
FXLR	1987-1994	9A	45141-87	STD = 40"	40"	101 cm	101 cm	<b>330-1868</b>	-
FXR, FXRS	1988-1994	9	45121-88	STD = 44"	44"	111 cm	111 cm	<b>330-1887</b>	-
<b>FXR 1985-1990 FRAM/ÖVRE+NEDRE (åtgår 1, innehåller 3 delar, 1 st övre + 2 st nedre)</b>									
FXRS	1985-1986		45136-85	STD		STD		<b>330-1894</b>	-
FXRS	1987-1993		45140-87	STD		STD		<b>330-1897</b>	-
FXRT	1985		45128-85	STD		STD		<b>330-1899</b>	-
FXRT, FXRD	1986-1987		45128-86	STD		STD		<b>330-1895</b>	-
FXRT	1988-1992		45128-88	STD		STD		<b>330-1889</b>	-
<b>FLT 1980-1982 FRAM/ÖVRE (åtgår 1)</b>									
FLT	1982	10	43331-82	STD = 22"	22"	STD = 55 cm	55 cm	<b>330-1837</b>	-
FLT	1982	10	43331-82	+2"	24"	+5 cm	60 cm	<b>330-1838</b>	-
FLT	1982	10	43331-82	+4"	26"	+10 cm	65 cm	<b>330-1839</b>	-
<b>FLT, FLHT 1983-1990 FRAM/ÖVRE+NEDRE (åtgår 1, innehåller 3 delar, 1 st övre + 2 st nedre)</b>									
FLT(C), FLHT(C)	1983		43349-83	STD		STD		<b>330-1892</b>	-
FLT, FLHT	1984-1995		43349-84	STD		STD		<b>330-1871</b>	-
FLHS	1987-1990		43349-84	STD		STD		<b>330-1871</b>	-

**SBS bromsklossar till Harley Davidson, Buell och specialcaliprar.**

På följande sidor finns rekommendationstabeller för Harley Davidson och Buell, samt tabeller över bromsklossar passandes specialcaliprar. För att vara säker på att få rätt kloss bör du jämföra din nuvarande kloss med måttskisserna som finns på varje artikel.

**OBS!** Rekommendationstabellen på kommande sidor bygger på standard/original bromssystem.

**CERAMIC**

**STREET**



**HF = fram, LF = bak**

- keramisk sammansättning anpassad för landsväg och touring
- asbest- och blyfria
- lång livslängd
- mycket driftsäker
- bromsar säkert i såväl vått som torrt underlag
- kan även användas i caliprar som är originalutrustade med sintrade belägg

**SINTER**

**STREETexcel**



**HS = fram, LS = bak**

- För alla nyare kraftiga maskiner där en snabb och jämn inbromsning krävs
- asbest- och blyfria
- tillverkade av en patenterad blandning av koppar, brons och keramiskt material
- snabb nedkylning och nästan ingen mattning av bromsarna
- maximal friktion och minimalt slitage av bromsskivorna.

**WARNING! Montera aldrig sintrade bromsklossar i caliprar som har icke sintrade bromsklossar originalmonterade.**

**DUAL  
CARBON**

**RACING**



**DC = fram+bak**

- avsedda för extrem racing, fram och bak
- asbest- och blyfria
- inbromsade efter 8-10 stopp
- minimalt slitage på gjutna och rostfria original bromsskivor
- lång livslängd

**OBSERVERA! DC-belägg är endast avsedda för racingbruk på bana.**



**SINTER****OFF-ROAD  
RACING**

## RSI = fram+bak

- avsedda för Grand Prix Moto Cross, fram och bak
- asbest- och blyfria
- optimal bromsverkan under blöta och leriga förhållanden

**WARNING! Montera aldrig sintrade bromsklossar i caliprar som har icke sintrade bromsklossar originalmonterade.**

**SINTER****OFF-ROAD**

## SI = fram+bak

- avsedda för off-road och ATV, fram och bak
- asbest- och blyfria
- optimal bromsverkan under blöta, sandiga och leriga förhållanden
- lång livslängd utan att tappa i bromsverkan

**WARNING! Montera aldrig sintrade bromsklossar i caliprar som har icke sintrade bromsklossar originalmonterade.**



Rekommenderas



Alternativ



Vissa bromssystem kan vara ombyggda - jämför dina befintliga bromsklossar med måttskisserna på sidorna 13-14, för att vara säker på att få rätt klossar.

HARLEY DAVIDSON				Rekommenderas		Alternativ			
Modell	År	Series	År	SBS579HS*	SBS668LS	HF	LF	HS	LS
FLT		Series	1988-1999	SBS579HS*	SBS668LS	•	•	•	•
FLT/H		Series	1986-1987	SBS579HS*	SBS668LS	•	•	•	•
FXB		Series	1974-1977	SBS679HF	-	•			
FXE		Series	1974-1977	SBS679HF	SBS513LF	•	•		
XL		Series	1974-1977	SBS679HF	-	•			
XLH		Series	1988-1999	SBS579HS*	SBS669LS	•	•	•	•
XL	883	R Sportster	2000-2003	SBS750HS	SBS750LS	•	•	•	•
XL	883	Sportster Custom	2000-2003	SBS750HS	SBS750LS	•	•	•	•
XL	883	C Sportster Custom	2004-	SBS807HS	SBS808LS			•	•
XL	883	Sportster	2004-	SBS807HS	SBS808LS			•	•
XL	883	L Sportster Low	2006	SBS807HS	SBS808LS			•	•
XLH	883		1970-1983	SBS537HF	-	•			
XLH	883	Sportster	1985-1986	SBS579HF	SBS549LF	•	•		
XLH	883	Sportster	1987-1989	SBS579HF	SBS669LF	•	•		
XLH	883	Sportster	1990-1999	SBS579HF	SBS669LF	•	•		
XLH	883	Sportster	2000-2003	SBS750HS	SBS750LS	•	•	•	•
XLH	883	Sportster Hugger	2000-2003	SBS750HS	SBS750LS	•	•	•	•
XL	1000		1978	SBS537HF	SBS543LF	•	•		
XLCH	1000		1973	SBS513HF	-	•			
XLCH	1000		1978-1980	SBS537HF	SBS543LF	•	•		
XLH	1000	Sportster	1979-1982	SBS537HF*	SBS543LF	•	•		
XLH	1000	Sportster	1983-1985	SBS537HF*	SBS549LF	•	•		

\* = dubbla skivor, beställ två par bromsklossar

Fortsättning nästa uppslag.

**Fortsättning. HARLEY DAVIDSON**

XLS	1000	Roadster	1979-1982	<b>SBS537HF*</b>	<b>SBS543LF</b>	•	•						
XLS	1000	Anniversary	1982	<b>SBS537HF*</b>	<b>SBS549LF</b>	•	•						
XLS	1000	Sportster	1983	<b>SBS537HF*</b>	<b>SBS549LF</b>	•	•						
XLX	1000	61	1983	<b>SBS537HF*</b>	<b>SBS549LF</b>	•	•						
XLX	1000	61	1984	<b>SBS537HF</b>	<b>SBS549LF</b>	•	•						
XR	1000		1985	<b>SBS537HF*</b>	<b>SBS549LF</b>	•	•						
XLH	1100	Sportster	1985-1986	<b>SBS579HF</b>	<b>SBS549LF</b>	•	•						
XLH	1100		1987-1988	<b>SBS579HS</b>	<b>SBS669LS</b>	•	•	•	•				
XLX	1100		1986	<b>SBS579HF</b>	<b>SBS549LF</b>	•	•						
VRSCA	1130	V-Rod	2002-	<b>SBS750HS*</b>	<b>SBS750LS</b>	•	•	•	•				
VRSCA	1130	V-Rod	2006	<b>SBS830HS*</b>	<b>SBS830LS</b>			•	•				
VRSCB	1130	V-Rod	2004-	<b>SBS750HS*</b>	<b>SBS750LS</b>	•	•	•	•				
VRSCD	1130	Night Rod	2006	<b>SBS830HS*</b>	<b>SBS830LS</b>			•	•				
VRSCR	1130	Street Rod	2006	<b>SBS830HS*</b>	<b>SBS830LS</b>			•	•				
FL	1200	FLH Police	1975-1979	<b>SBS513HF</b>	<b>SBS513LF</b>	•	•						
FLH	1200		1974-1976	<b>SBS513HF</b>	<b>SBS513LF</b>	•	•						
FLH	1200	Touring	1977-1978	<b>SBS513HF</b>	<b>SBS513LF</b>	•	•						
FLH	1200	Anniversary	1978	<b>SBS513HF</b>	<b>SBS513LF</b>	•	•						
FLH	1200		1980	<b>SBS513HF</b>	<b>SBS553LF</b>	•	•						
FLHS	1200		1977-1980	<b>SBS513HF</b>	<b>SBS513LF</b>	•	•						
FX	1200		1974-1980	<b>SBS537HF</b>	<b>SBS513LF</b>	•	•						
FXE	1200		1974-1980	<b>SBS537HF</b>	<b>SBS513LF</b>	•	•						
FXS	1200		1978-1979	<b>SBS537HF</b>	<b>SBS513LF</b>	•	•						
XL	1200	Sportster Custom	2000-2003	<b>SBS750HS</b>	<b>SBS750LS</b>	•	•	•	•				
XL	1200	Sportster Sport	2000-2003	<b>SBS750HS*</b>	<b>SBS750LS</b>	•	•	•	•				
XL	1200	C Sportster Custom	2004-	<b>SBS807HS</b>	<b>SBS808LS</b>			•	•				
XL	1200	R Sportster Roadster	2004-	<b>SBS807HS*</b>	<b>SBS808LS</b>			•	•				
XLH	1200	Sportster	1990-1999	<b>SBS579HS</b>	<b>SBS669LS</b>	•	•	•	•				
XLH	1200	Sportster	2000-2003	<b>SBS750HS</b>	<b>SBS750LS</b>	•	•	•	•				
FLH	1340	80	1978-1980	<b>SBS513HF</b>	<b>SBS513LF</b>	•	•						
FLH	1340	80	1981	<b>SBS513HF</b>	<b>SBS553LF</b>	•	•						
FLH	1340	Heritage	1981	<b>SBS543HF*</b>	<b>SBS553LF</b>	•	•						
FLH	1340	Classic	1982-1983	<b>SBS543HF*</b>	<b>SBS553LF</b>	•	•						
FLH	1340	Electra Glide	1982-1983	<b>SBS543HF*</b>	<b>SBS513LF</b>	•	•						
FLH	1340	Electra Glide Spec.	1984	<b>SBS513HF</b>	<b>SBS553LF</b>	•	•						
FLHS	1340	Electra Glide Sport	1990	<b>SBS579HS*</b>	<b>SBS668LS</b>	•	•	•	•				
FLHT	1340	Electra Glide	1985-1986	<b>SBS579HF*</b>	<b>SBS549LF</b>	•	•						
FLHT	1340	Electra Glide Classic	1987-1999	<b>SBS579HS*</b>	<b>SBS669LS</b>	•	•	•	•				
FLHTC	1340	Electra Glide Classic	1985-1986	<b>SBS579HF*</b>	<b>SBS549LF</b>	•	•						
FLHTC	1340	Electra Glide Classic	1990-1999	<b>SBS579HS*</b>	<b>SBS668LS</b>	•	•	•	•				
FLHTC	1340	Ultra Classic	1990-1999	<b>SBS579HS*</b>	<b>SBS668LS</b>	•	•	•	•				
FLHTC	1340	Electra Glide Classic	1993	<b>SBS579HS*</b>	<b>SBS669LS</b>	•	•	•	•				
FLST	1340	Heritage Softail	1986-1987	<b>SBS579HF</b>	<b>SBS549LF</b>	•	•						
FLST	1340	Heritage Softail	1988-1999	<b>SBS579HS</b>	<b>SBS668LS</b>	•	•	•	•				
FLSTC	1340	Heritage Softail Cl.	1990-1999	<b>SBS579HS</b>	<b>SBS669LS</b>	•	•	•	•				
FLSTF	1340	Fat Boy	1990-1999	<b>SBS579HS</b>	<b>SBS669LS</b>	•	•	•	•				
FLSTN	1340	Heritage Softail Nost.	1993-1999	<b>SBS579HS*</b>	<b>SBS669LS</b>	•	•	•	•				
FLT	1340	80	1980-1981	<b>SBS543HF*</b>	<b>SBS553LF</b>	•	•						
FLT	1340	80 Classic	1981	<b>SBS543HF*</b>	<b>SBS553LF</b>	•	•						
FLT	1340	Classic	1982-1983	<b>SBS543HF*</b>	<b>SBS553LF</b>	•	•						
FLT	1340	Tour Glide	1982	<b>SBS543HF*</b>	<b>SBS553LF</b>	•	•						
FLT	1340		1984-1985	<b>SBS579HF</b>	<b>SBS553LF</b>	•	•						
FLTC	1340	Tour Glide Classic	1985-1986	<b>SBS579HF</b>	<b>SBS549LF</b>	•	•						
FLTC	1340	Tour Glide Classic	1990	<b>SBS579HS*</b>	<b>SBS668LS</b>	•	•	•	•				
FLTH	1340	Tour Glide	1984	<b>SBS537HF*</b>	<b>SBS553LF</b>	•	•						

Vissa bromssystem kan vara ombyggda - jämför dina befintliga bromsklossar med måttkisserna på sidorna 13-14, för att vara säkra på att få rätt klossar.

\* = dubbla skivor, beställ två par bromsklossar

Fortsättning. **HARLEY DAVIDSON**

FXB	1340	80	1980-1981	SBS537HF	SBS513LF	•	•						
FXB	1340	Sturgis	1982	SBS537HF*	SBS513LF	•	•						
FXDB	1340	Dyna Glide Daytona	1991-1999	SBS579HS*	SBS669LS	•	•	•	•				
FXDB	1340	Dyna Glide Sturgis	1991-1999	SBS579HF	SBS669LF	•	•						
FXDB	1340	Sturgis	1991-1999	SBS579HS	SBS669LS	•	•	•	•				
FXDL	1340	Dyna Low Rider	1993-1999	SBS579HS*	SBS669LS	•	•	•	•				
FXDWG	1340	Dyna Wide Glide	1993-1999	SBS579HS	SBS669LS	•	•	•	•				
FXE	1340	80	1978-1981	SBS537HF	SBS513LF	•	•						
FXE	1340		1982	SBS537HF	SBS669LF	•	•						
FXE	1340	Super Glide	1983-1984	SBS537HF*	SBS513LF	•	•						
FXE	1340		1985-1986	SBS579HF	SBS549LF	•	•						
FXEF	1340	80 Fat Bob	1979-1981	SBS537HF	SBS513LF	•	•						
FXLR	1340	Low Rider Custom	1987-1988	SBS579HS	SBS669LS	•	•	•	•				
FXLR	1340	Low Rider Custom	1993-1999	SBS579HS	SBS669LS	•	•	•	•				
FXR	1340		1978-1981	SBS537HF	SBS513LF	•	•						
FXR	1340	Super Glide	1982-1983	SBS537HF	SBS549LF	•	•						
FXR	1340	Super Glide	1985-1986	SBS579HF	SBS549LF	•	•						
FXR	1340		1987-1988	SBS579HS	SBS669LS	•	•	•	•				
FXR	1340	Super Glide	1990-1999	SBS579HS	SBS669LS	•	•	•	•				
FXRD	1340	Sport Glide GTE	1985-1986	SBS579HF*	SBS549LF	•	•						
FXRS	1340	Low Glide	1982-1984	SBS537HF*	SBS549LF	•	•						
FXRS	1340	Super Glide II	1982-1983	SBS537HF*	SBS549LF	•	•						
FXRS	1340	Low Rider	1985-1986	SBS579HF*	SBS549LF	•	•						
FXRS	1340	Low Rider Sport	1987-1999	SBS579HS*	SBS669LS	•	•	•	•				
FXRS	1340	Low Rider Convert.	1990-1999	SBS579HS*	SBS669LS	•	•	•	•				
FXRS	1340	Low Rider Sport Ed.	1990-1999	SBS579HS*	SBS669LS	•	•	•	•				
FXRT	1340	Super Glide II	1983	SBS537HF	SBS549LF	•	•						
FXRT	1340	Sport Glide	1985-1986	SBS579HF*	SBS549LF	•	•						
FXRT	1340	Sport Glide	1990-1999	SBS579HS*	SBS669LS	•	•	•	•				
FXS	1340	80	1979-1981	SBS537HF	SBS513LF	•	•						
FXS	1340	Low Rider	1982	SBS537HF*	SBS513LF	•	•						
FXSB	1340	Low Rider	1983	SBS537HF*	SBS549LF	•	•						
FXST	1340	Softail	1984-1986	SBS579HF	SBS549LF	•	•						
FXSTC	1340	Softail Custom	1985-1986	SBS579HF	SBS549LF	•	•						
FXSTC	1340	Softail Custom	1988-1999	SBS579HS	SBS669LS	•	•	•	•				
FXSTS	1340	Springer Softail	1990-1999	SBS579HS	SBS669LS	•	•	•	•				
FXWG	1340	80	1980-1981	SBS537HF	SBS513LF	•	•						
FXWG	1340	Wide Glide	1982	SBS537HF*	SBS513LF	•	•						
FXWG	1340	Wide Glide	1983	SBS537HF*	SBS549LF	•	•						
FXWG	1340	Wide Glide	1984	SBS537HF	SBS549LF	•	•						
FXWG	1340	Wide Glide	1985-1986	SBS579HF	SBS549LF	•	•						
FXWG	1340		1987-1988	SBS579HS	SBS669LS	•	•	•	•				
FLHR/I	1450	Road King	2000-2004	SBS750HS*	SBS750LS	•	•	•	•				
FLHR/I	1450	Road King	2005-	SBS826HS*	SBS826LS					•	•		
FLHRCI	1450	Road King Classic	2000-2004	SBS750HS*	SBS750LS	•	•	•	•				
FLHRCI	1450	Road King Classic	2005-	SBS826HS*	SBS826LS					•	•		
FLHRS/I	1450	Road King Custom	2004	SBS750HS*	SBS750LS	•	•	•	•				
FLHRS/I	1450	Road King Custom	2005-	SBS826HS*	SBS826LS					•	•		
FLHT/I	1450	Electra Glide Standard	2000-2004	SBS750HS*	SBS750LS	•	•	•	•				
FLHT/I	1450	Electra Glide Standard	2005-	SBS826HS*	SBS826LS					•	•		
FLHTC/I	1450	Electra Glide Classic	2000-	SBS750HS*	SBS750LS	•	•	•	•				
FLHTC/I	1450	Electra Glide Classic	2005-	SBS826HS*	SBS826LS					•	•		
FLHTCUI	1450	Ultra Classic Electra Glide	2000-2004	SBS750HS*	SBS750LS	•	•	•	•				
FLHTCUI	1450	Ultra Classic Electra Glide	2005-	SBS826HS*	SBS826LS					•	•		
FLHXI	1450	Street Glide	2006	SBS826HS*	SBS826LS					•	•		

Vissa bromssystem kan vara ombyggda - jämför dina befintliga bromsklossar med måttskisserna på sidorna 13-14, för att vara säker på att få rätt klossar.

\* = dubbla skivor, beställ två par bromsklossar

Fortsättning nästa uppslag.

**Fortsättning. HARLEY DAVIDSON**

FLSTC/I	1450	Heritage Softail Classic	2000-2004	<b>SBS750HS</b>	<b>SBS750LS</b>	•	•	•	•
FLSTC/I	1450	Heritage Softail Classic	2005-	<b>SBS826HS</b>	<b>SBS826LS</b>			•	•
FLSTF/I	1450	Fat Boy	2000-2004	<b>SBS750HS</b>	<b>SBS750LS</b>	•	•	•	•
FLSTF/I	1450	Fat Boy	2005-	<b>SBS826HS</b>	<b>SBS826LS</b>			•	•
FLSTI	1450	Heritage Softail	2006	<b>SBS826HS</b>	<b>SBS826LS</b>			•	•
FLSTN/I	1450	Softail Deluxe	2005-	<b>SBS826HS</b>	<b>SBS826LS</b>			•	•
FLSTS/I	1450	Heritage Springer	2000-2003	<b>SBS579HS</b>	<b>SBS750LS</b>	•	•	•	•
FLSTSC/I	1450	Springer Softail Classic	2005-	<b>SBS579HS</b>	<b>SBS826LS</b>	•		•	•
FLTR/I	1450	Road Glide	2000-	<b>SBS750HS*</b>	<b>SBS750LS</b>	•	•	•	•
FLTR/I	1450	Road Glide Classic	2000-2004	<b>SBS750HS*</b>	<b>SBS750LS</b>	•	•	•	•
FLTR/I	1450	Road Glide Classic	2005-	<b>SBS826HS*</b>	<b>SBS826LS</b>			•	•
FXD	1450	Dyna Super Glide	2000-2003	<b>SBS750HS</b>	<b>SBS750LS</b>	•	•	•	•
FXDBI	1450	Dyna Street Bob	2006	<b>SBS826HS</b>	<b>SBS826LS</b>			•	•
FXDC/I	1450	Dyna Super Glide Custom	2005-	<b>SBS826HS</b>	<b>SBS826LS</b>			•	•
FXDI	1450	Dyna Super Glide	2004	<b>SBS750HS</b>	<b>SBS750LS</b>	•	•	•	•
FXDI	1450	Dyna Super Glide	2005-	<b>SBS826HS</b>	<b>SBS826LS</b>			•	•
FXDI	1450	35th Anniversary Super Glide	2006	<b>SBS826HS</b>	<b>SBS826LS</b>			•	•
FXDL	1450	Dyna Low Rider	2000-2003	<b>SBS750HS*</b>	<b>SBS750LS</b>	•	•	•	•
FXDLI	1450	Dyna Low Rider	2004	<b>SBS750HS</b>	<b>SBS750LS</b>	•	•	•	•
FXDLI	1450	Dyna Low Rider	2005-	<b>SBS826HS</b>	<b>SBS826LS</b>			•	•
FXDS	1450	Dyna Convertible	2000-2002	<b>SBS750HS*</b>	<b>SBS750LS</b>	•	•	•	•
FXDWG	1450	Dyna Wide Glide	2000-2003	<b>SBS750HS</b>	<b>SBS750LS</b>	•	•	•	•
FXDWGI	1450	Dyna Wide Glide	2004	<b>SBS750HS</b>	<b>SBS750LS</b>	•	•	•	•
FXDWGI	1450	Dyna Wide Glide	2005-	<b>SBS826HS</b>	<b>SBS826LS</b>			•	•
FXDX	1450	Dyna Super Glide Sport	2000-2003	<b>SBS750HS*</b>	<b>SBS750LS</b>	•	•	•	•
FXDXI	1450	Dyna Super Glide Sport	2004	<b>SBS750HS</b>	<b>SBS750LS</b>	•	•	•	•
FXDXI	1450	Dyna Super Glide Sport	2005-	<b>SBS826HS</b>	<b>SBS826LS</b>			•	•
FXDXT	1450	Dyna Super Glide T-Sport	2000-2003	<b>SBS750HS*</b>	<b>SBS750LS</b>	•	•	•	•
FXST/I	1450	Softail Standard	2000-2004	<b>SBS750HS</b>	<b>SBS750LS</b>	•	•	•	•
FXST/I	1450	Softail Standard	2005-	<b>SBS826HS</b>	<b>SBS826LS</b>			•	•
FXSTB/I	1450	Night Train	2000-2004	<b>SBS750HS</b>	<b>SBS750LS</b>	•	•	•	•
FXSTB/I	1450	Night Train	2005-	<b>SBS826HS</b>	<b>SBS826LS</b>			•	•
FXSTD/I	1450	Softail Deuce	2000-2004	<b>SBS750HS</b>	<b>SBS750LS</b>	•	•	•	•
FXSTD/I	1450	Softail Deuce	2005-	<b>SBS826HS</b>	<b>SBS826LS</b>			•	•
FXSTI	1450	Softail Standard	2000-	<b>SBS750HS</b>	<b>SBS750LS</b>	•	•	•	•
FXSTS/I	1450	Springer Softail	2000-2004	<b>SBS579HS</b>	<b>SBS750LS</b>	•	•	•	•
FXSTS/I	1450	Springer Softail	2005-	<b>SBS579HS</b>	<b>SBS826LS</b>	•		•	•

**BUELL**

		alla modeller	1994-1997	<b>SBS658HF</b>	<b>SBS692LF</b>	•	•		
	500	Blast	2001-	<b>SBS627HF</b>	<b>SBS614LF</b>	•	•		
XB9R	984	Firebolt	2002-	<b>SBS795HS</b>	<b>SBS614LS</b>	•	•	•	•
XB9S	984	Lightning	2003-	<b>SBS795HS</b>	<b>SBS614LS</b>	•	•	•	•
XB9SX	984	CityX	2005-	<b>SBS795HS</b>	<b>SBS614LS</b>	•	•	•	•
M2	1200	Cyclone	1998-2002	<b>SBS676HS</b>	<b>SBS614LS</b>	•	•	•	•
RS	1200			<b>SBS658HF</b>	<b>SBS692LF</b>	•	•		
S1	1200	Lightning	1998-2002	<b>SBS676HS</b>	<b>SBS614LS</b>	•	•	•	•
S1	1200	Whitelighting	1998-2002	<b>SBS676HS</b>	<b>SBS614LS</b>	•	•	•	•
S3	1200	Thunderbolt	1998-2002	<b>SBS676HS</b>	<b>SBS614LS</b>	•	•	•	•
X1	1200	Lightning	2001-2002	<b>SBS676HS</b>	<b>SBS614LS</b>	•	•	•	•
XB12R	1200	Firebolt	2004-	<b>SBS795HS</b>	<b>SBS614LS</b>	•	•	•	•
XB12S	1200	Lightning	2004-	<b>SBS795HS</b>	<b>SBS614LS</b>	•	•	•	•
XB12Ss	1200	Lightning Long	2006	<b>SBS795HS</b>	<b>SBS614LS</b>	•	•	•	•
XB12X	1200	Ulysses	2006	<b>SBS795HS</b>	<b>SBS614LS</b>	•	•	•	•

Vissa bromssystem kan vara ombyggda - jämför dina befintliga bromsklossar med måttskisserna på sidorna 13-14, för att vara säkra på att få rätt klossar.

\* = dubbla skivor, beställ två par bromsklossar

**SBS513**    **HF**    **LF**

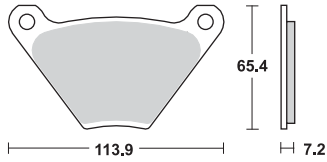

**SBS537**    **HF**

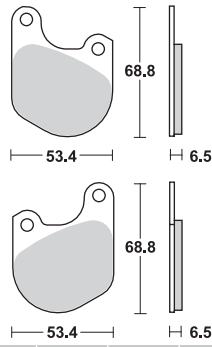

**SBS543**    **HF**    **LF**

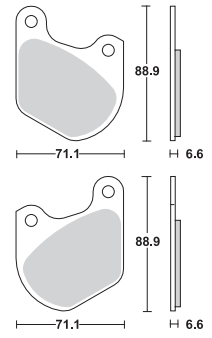

**SBS549**    **LF**

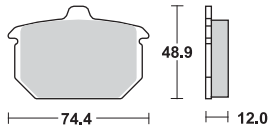

**SBS553**    **LF**

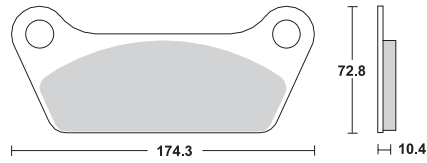

**SBS579**    **HF**    **HS**

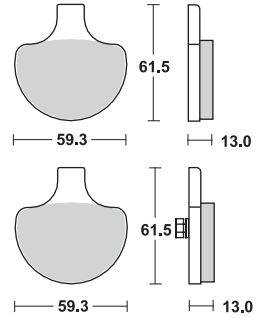

**SBS614**    **LF**    **LS**

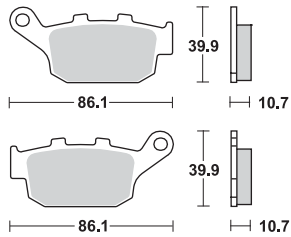

**SBS627**    **HF**    **LF**    **HS**

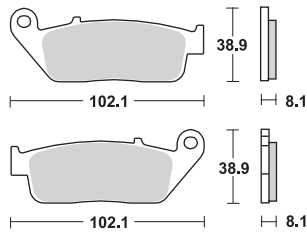

**SBS658**    **HF**

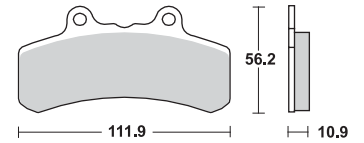

**SBS668**    **LF**    **LS**

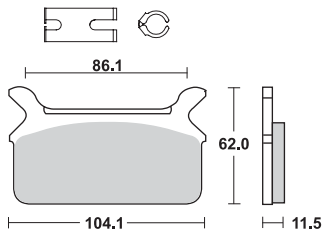

**SBS669**    **LF**    **LS**

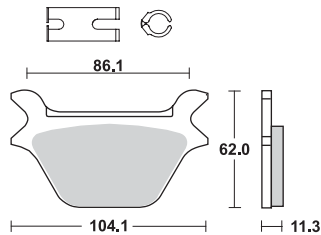

**SBS676**    **HF**    **HS**

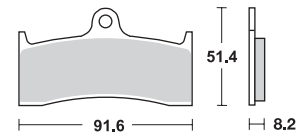

**SBS679**    **HF**

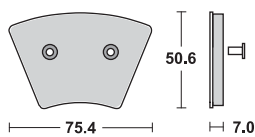

**SBS692**    **HF**    **LF**

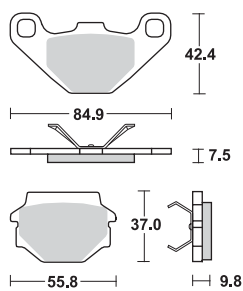

**SBS750**    **HF**    **LF**    **HS**    **LS**

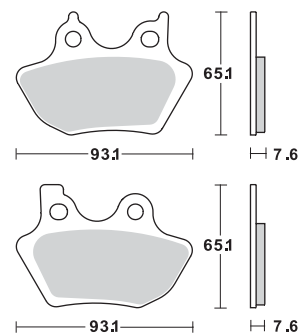

Fortsättning nästa uppslag.

<b>SBS795</b>	<b>HF</b>	<b>HS</b>		
---------------	-----------	-----------	--	--

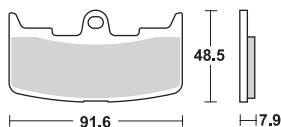

<b>SBS807</b>		<b>HS</b>		
---------------	--	-----------	--	--

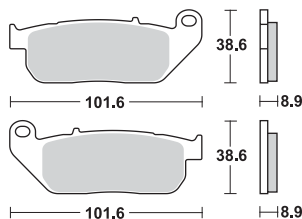

<b>SBS808</b>				<b>LS</b>
---------------	--	--	--	-----------

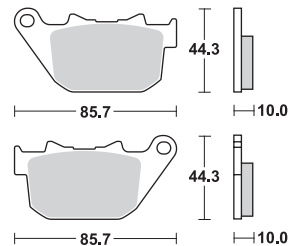

<b>SBS826</b>		<b>HS</b>	<b>LS</b>
---------------	--	-----------	-----------

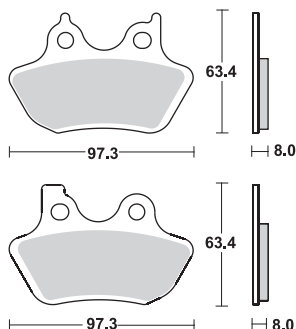

<b>SBS830</b>		<b>HS</b>	<b>LS</b>
---------------	--	-----------	-----------

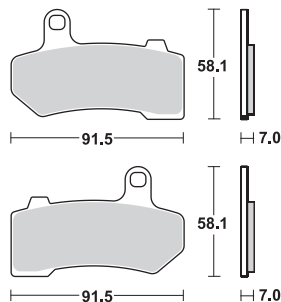

Se sid. 8-9 för förklaring av de olika typerna av bromsklossar (HF/LF/HS/LS/DC/RSI/SI).

## SBS bromsklossar till specialcaliprar

<b>SBS504</b>	<b>HF</b>	<b>LF</b>		
---------------	-----------	-----------	--	--

ISR 2-kolvs caliprar

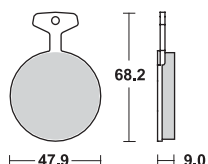

<b>SBS506</b>	<b>HF</b>	<b>LF</b>	<b>HS</b>	<b>LS</b>
---------------	-----------	-----------	-----------	-----------

Brembo caliprar

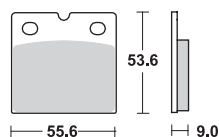

<b>SBS519</b>	<b>HF</b>	<b>LF</b>	<b>DC</b>	<b>SI</b>	<b>RSI</b>	<b>LS</b>
---------------	-----------	-----------	-----------	-----------	------------	-----------

Brembo caliprar

ISR 2/4-kolvs caliprar

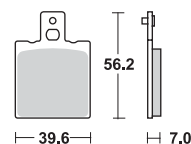

<b>SBS523</b>	<b>HF</b>	<b>LF</b>		
---------------	-----------	-----------	--	--

AP Racing caliprar

ISR 2-kolvs caliprar

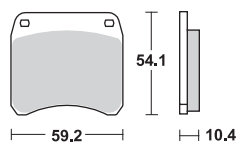

<b>SBS559</b>	<b>HF</b>	<b>LF</b>		<b>RSI</b>
---------------	-----------	-----------	--	------------

GMA caliprar

Jaybrake caliprar

Performance Machine caliprar

SJP caliprar

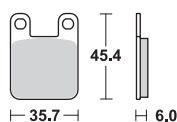

<b>SBS574</b>	<b>HF</b>	<b>LF</b>	<b>SI</b>	<b>RSI</b>
---------------	-----------	-----------	-----------	------------

Brembo caliprar

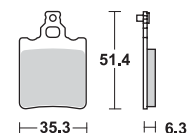

<b>SBS655</b>	<b>HF</b>			<b>DC</b>
---------------	-----------	--	--	-----------

ISR 2/4/6-kolvs caliprar

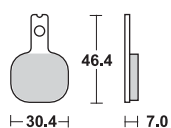

<b>SBS656</b>	<b>HF</b>			<b>DC</b>
---------------	-----------	--	--	-----------

ISR 6-kolvs caliprar

Harrison/Billet caliprar

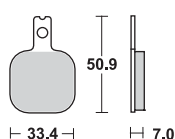

Se sid. 8-9 för förklaring av de olika typerna av bromsklossar (HF/LF/HS/LS/DC/RSI/SI).

OBS! Denna artikel säljs i set om 3 par = totalt 6 st klossar

[www.roffesmotor.se](http://www.roffesmotor.se)

OBS! Denna artikel säljs i set om 3 par = totalt 6 st klossar

## Rekommenderade ca-priser inklusive 25% moms

330-1825	st	495.00	330-1899	sats	1125.00	SBS519LS	par	190.00
330-1826	st	495.00	330-1900	st	465.00	SBS519RSI	par	215.00
330-1827	st	495.00	330-1902	st	465.00	SBS519SI	par	195.00
330-1829	st	495.00	330-1904	st	465.00	SBS523HF	par	210.00
330-1830	st	495.00	330-1906	st	465.00	SBS523LF	par	220.00
330-1831	st	495.00	330-1908	st	465.00	SBS523RCA	par	285.00
330-1833	st	525.00	330-1910	st	465.00	SBS537HF	par	210.00
330-1834	st	495.00	330-1912	st	465.00	SBS543HF	par	290.00
330-1835	st	495.00	330-1913	st	465.00	SBS543LF	par	305.00
330-1837	st	465.00	330-1914	st	465.00	SBS549LF	par	325.00
330-1838	st	465.00	330-1915	st	465.00	SBS553LF	par	320.00
330-1839	st	465.00	330-1916	st	465.00	SBS559HF	par	240.00
330-1841	st	525.00	330-1917	st	465.00	SBS559LF	par	255.00
330-1847	st	525.00	330-1918	st	465.00	SBS559RSI	par	290.00
330-1849	st	785.00	330-1919	st	370.00	SBS574HF	par	210.00
330-1850	st	525.00	330-1920	st	465.00	SBS574LF	par	220.00
330-1852	st	525.00	330-1921	par	765.00	SBS574RSI	par	255.00
330-1853	st	525.00	330-1922	par	765.00	SBS574SI	par	230.00
330-1854	st	525.00	330-1923	par	765.00	SBS579HF	par	285.00
330-1855	st	525.00	330-1930	st	465.00	SBS579HS	par	330.00
330-1856	st	525.00	330-1931	st	465.00	SBS614LF	par	270.00
330-1857	st	525.00	330-1932	par	765.00	SBS614LS	par	295.00
330-1858	st	525.00	330-1950	st	255.00	SBS627HF	par	290.00
330-1859	st	465.00	330-1951	st	255.00	SBS627HS	par	315.00
330-1860	st	465.00	330-1952	st	255.00	SBS627LF	par	305.00
330-1861	st	465.00	330-1954	st	280.00	SBS655DC	3par	1195.00
330-1864	st	465.00	330-1955	par	330.00	SBS655HF	3par	750.00
330-1865	st	465.00	330-1965	st	300.00	SBS656DC	3par	1195.00
330-1866	st	465.00	330-1966	st	310.00	SBS656HF	3par	750.00
330-1867	sats	1175.00	330-1967	st	310.00	SBS658HF	par	415.00
330-1868	st	525.00	330-1969	st	340.00	SBS668LF	par	365.00
330-1869	sats	1175.00	330-1973	st	230.00	SBS668LS	par	440.00
330-1870	st	465.00	330-1976	st	255.00	SBS669LF	par	360.00
330-1871	sats	1175.00	330-1977	st	265.00	SBS669LS	par	440.00
330-1872	sats	1175.00	330-1978	st	265.00	SBS676HF	par	460.00
330-1873	st	465.00	330-1979	st	280.00	SBS676HS	par	495.00
330-1874	st	465.00	330-1980	st	300.00	SBS679HF	par	110.00
330-1875	st	465.00	330-1983	st	230.00	SBS692HF	par	250.00
330-1876	st	465.00	330-1985	sats	875.00	SBS692LF	par	265.00
330-1877	st	465.00	330-1987	st	475.00	SBS750HF	par	285.00
330-1878	st	465.00	330-1989	st	415.00	SBS750HS	par	330.00
330-1879	st	495.00	330-1991	st	555.00	SBS750LF	par	300.00
330-1880	st	495.00	330-1993	st	475.00	SBS750LS	par	350.00
330-1882	st	525.00	330-1994	st	475.00	SBS795HF	par	450.00
330-1883	st	525.00	330-1995	st	475.00	SBS795HS	par	495.00
330-1884	st	525.00	330-1996	st	475.00	SBS807HS	par	330.00
330-1885	st	525.00	330-1997	st	475.00	SBS808LS	par	345.00
330-1886	st	525.00	330-1998	st	475.00	SBS826HS	par	360.00
330-1887	st	525.00	330-1999	st	435.00	SBS826LS	par	375.00
330-1888	st	525.00	SBS504HF	par	190.00	SBS830HS	par	360.00
330-1889	sats	1175.00	SBS504LF	par	195.00	SBS830LS	par	375.00
330-1890	st	465.00	SBS506HF	par	210.00	SBS3908	st	1250.00
330-1891	sats	1175.00	SBS506HS	par	290.00	SBS9500	2par	70.00
330-1892	sats	1175.00	SBS506LF	par	220.00			
330-1893	st	465.00	SBS506LS	par	305.00			
330-1894	sats	1175.00	SBS513HF	par	210.00			
330-1895	sats	1175.00	SBS513LF	par	220.00			
330-1896	st	465.00	SBS519DC	par	250.00			
330-1897	sats	1175.00	SBS519HF	par	155.00			
330-1898	st	465.00	SBS519LF	par	165.00			

avsändare:

**ROFFES MOTOR AB**  
Box 4905  
SE-116 94 Stockholm

**B**

SVERIGE  
PORTO BETALT  
PORT PAYÉ



**SBS luftningsverktyg**

Ett unikt verktyg som luftar och byter bromsvätska på ett snabbt, enkelt, och "rent" sätt. Verktöget kan lufta två caliprar samtidigt.

Drivs med tryckluft, minst 6 bar.

Utförlig bruksanvisning på 12 olika språk medföljer.

**Art.nr: SBS3908**



**SBS shims/gnisselskydd**

Glasfiberarmerad självhäftande gummiduk, 0,6 mm tjock. Motverkar vibrationer och gnissel, leder bort värme och skyddar bromskolven. Monteras på klossens baksida. Passar bromsklossar av alla fabrikat och storlekar. Levereras i sats om 2 par (4 st).

**Art.nr: SBS9500**

**I det här häftet presenterar vi bromsklossar till Harley Davidson och Buell. Söker du belägg till något annat märke kan du ladda ner hela SBS-katalogen från vår hemsida, [www.roffesmotor.se](http://www.roffesmotor.se), eller ringa oss på 08/640 43 46.**

**Totalt lagerhåller vi över 1000 olika bromsklossar och bromsbackar till de flesta mc, skotrar och ATV.**

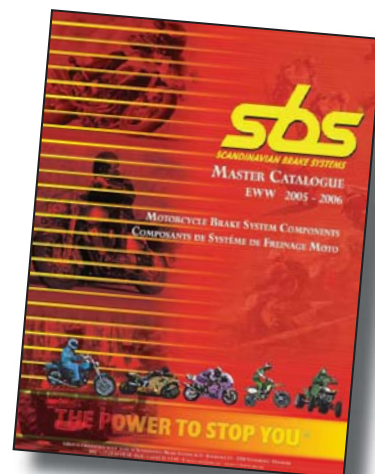

**ROFFES MOTOR AB**

Box 4905 • SE-116 94 STOCKHOLM

Tel +46 8 640 43 46 • Fax +46 8 714 92 92 • [www.roffesmotor.se](http://www.roffesmotor.se) • [info@roffesmotor.se](mailto:info@roffesmotor.se)